

PL-660

PLL SYNTHESIZED RECEIVER
FM STEREO / MW / LW / SW-SSB / AIR BAND

OPERATION MANUAL

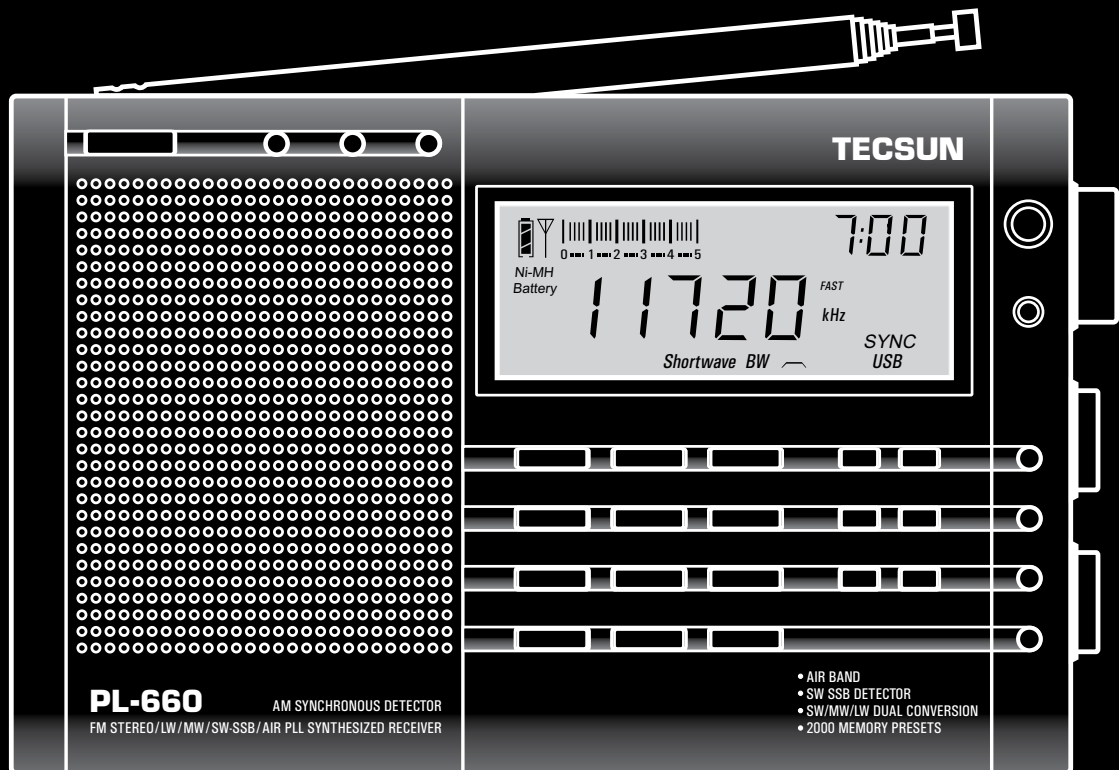
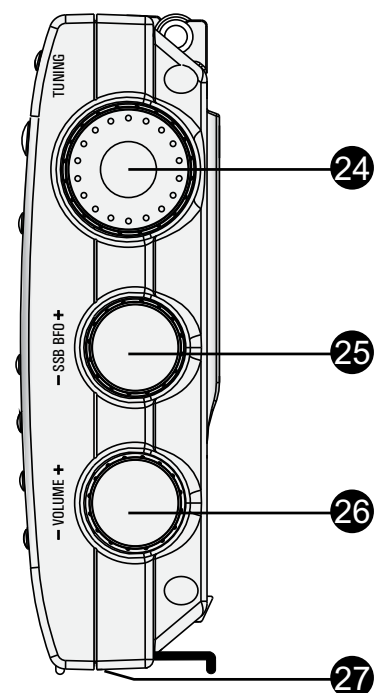
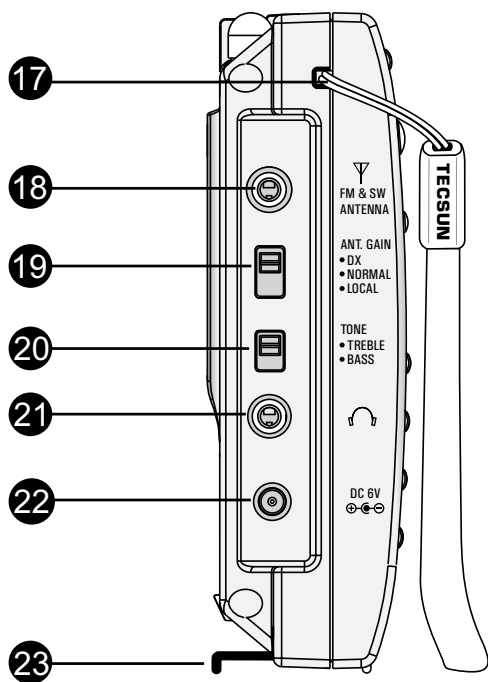
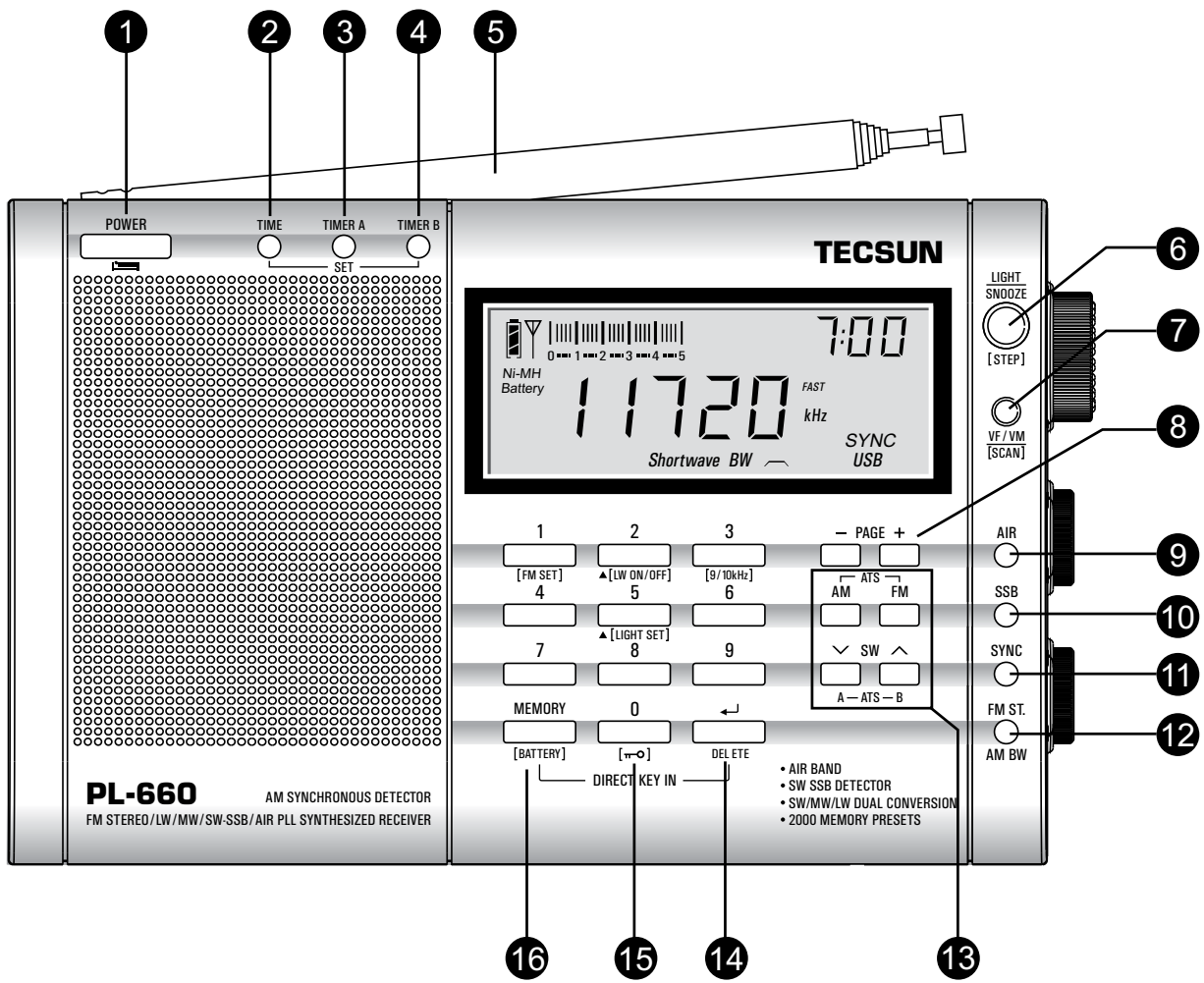

TABLE OF CONTENTS

CONTROL LOCATIONS.....	2
LCD DISPLAY.....	4
HOW TO TURN ON/OFF THE RADIO.....	5
TUNE IN STATIONS.....	6
● Manual Station Tuning	
● Auto Browse Station	
● Direct Keypad Entry	
WORKING WITH STATION MEMORIES.....	8
● Storing Station Manually	
● Semi-Automatic Storing Station	
● ATS (Auto Tuning Storage)	
● How to Select Different Memory Page	
● Memory Tuning Manually	
● Auto Browse Memory	
● Direct Key in Memory Address	
● Delete Single Memory Manually	
● Semi-Auto Delete Memory	
● Delete ALL Memory within the Page	
LISTENING TO STORED STATIONS.....	12
SLEEP FUNCTION.....	13
CLOCK SETTING.....	13
ALARM SETTING.....	14
SETTING ALARM STATION	
SETTING THE ALARM TIME	
SNOOZE FUNCTION.....	15
INTELLIGENT LIGHT FUNCTION.....	15
SETTING TUNING STEP.....	16
FM ST. (FM STEREO).....	16
AM BW (BANDWIDTH).....	17
ANT. GAIN.....	17
TONE CONTROL.....	17
KEY-LOCK FUNCTION.....	17
INTELLIGENT CHARGING FUNCTION.....	18
SINGLE SIDE BAND (SSB).....	18
SYNCHRONOUS DETECTOR.....	19
HOW TO IMPROVE FM / SW RECEPTION.....	19
SYSTEM SETTING.....	20
RESET PROCEDURE.....	21
IMPORTANT MATTERS FOR USING BATTERIES.....	21
TROUBLE SHOOTING.....	22
SPECIFICATIONS.....	23

CONTROL LOCATIONS





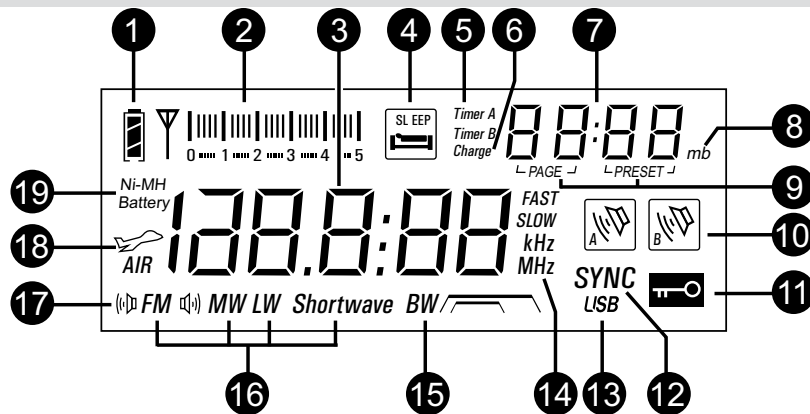

-
- ① Power / Sleep button
 - ② Time set button
 - ③ Timer A Alarm set button
 - ④ Timer B Alarm set button
 - ⑤ FM & SW Telescopic Antenna
 - ⑥ Light / Snooze / Step button
 - ⑦ VF / VM / SCAN
 - ⑧ -/+ PAGE buttons
 - ⑨ Air Band button
 - ⑩ Single Side Band (SSB) button
 - ⑪ Synchronous (SYNC) button
 - ⑫ FM. ST & AM BW select button
 - ⑬ FM / AM (MW, LW) / SW Band & ATS buttons
 - ⑭ Delete / Enter button
 - ⑮ Key lock button
 - ⑯ Memory / Battery button
 - ⑰ Hand Carry Belt
 - ⑱ FM / SW Antenna Jack
 - ⑲ ANT. Gain (DX / Normal / Local) switch
 - ⑳ Treble / Bass Tone Control
 - ㉑ Earphone Jack
 - ㉒ DC 6V Jack
 - ㉓ Metal Stand
 - ㉔ Tuning Knob
 - ㉕ SSB BFO knob
 - ㉖ Volume knob
 - ㉗ Reset button

Note: For the silk-printing in red or orange on radio with brackets, it means that you can only operate it when radio is off.

LCD DISPLAY

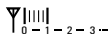

- ① Battery Consumption indicator
 - “” : Full
 - “” : Empty
- ② Signal Strength indicator
 - “” : Strong Signal
 - “” : Weak Signal
- ③ Digital Number Display:
 - With radio off: Time & System settings
 - With radio on: Frequency or Error display
- ④ Sleep timer indicator
- ⑤ Alarm Timer A or B – Timer indicator
- ⑥ Charging Indicator
- ⑦ Digital Number Display:
 - With radio off: preset alarm time and charging time
 - With radio on: time, page & memory address, SW meter band displays.
- ⑧ SW meter band indicator
- ⑨ PAGE: Memory Page number
PRESET: Memory Address number
- ⑩ Alarm Timer A or B - On/Off indicator
- ⑪ Key-Lock indicator
- ⑫ Synchronous band detection
- ⑬ Single Side Band (SSB) indicator
USB: Upper Side Band
LSB: Lower Side Band
- ⑭ Tuning Speed:
 - Slow: Slow Tuning
 - Fast: Fast Tuning
 - KHz: frequency unit for MW, LW & SW
 - MHz: frequency unit for FM
- ⑮ AM Band width indicator
 -  : AM Wide band
 -  : AM Narrow band
- ⑯ FM, MW, LW and SW Band indicator
- ⑰ FM Stereo indicator
- ⑱ Air Band indicator
- ⑲ Ni-MH Rechargeable Battery indicator

HOW TO TURN ON/OFF THE RADIO

1. Open the battery compartment located on the back of the unit; install 4 x UM3 AA alkaline batteries observing the battery polarity diagram on the back of the radio. Close the battery door.

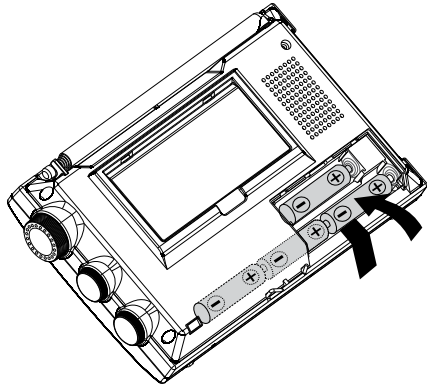

Connect the unit to the regulated power supply.

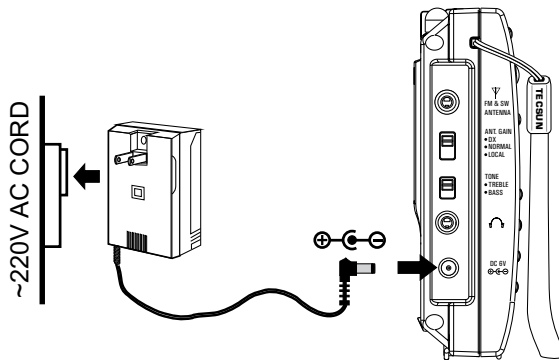

2. Press on the [POWER] button to turn on the radio.

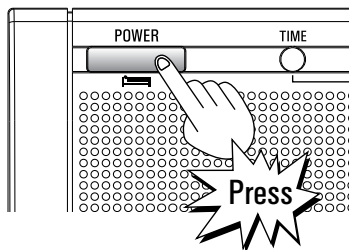

Note:

If the radio is unable to be turned on, please check if the batteries were installed correctly, battery capacity is sufficient or the lock function had been applied with "[

Long press on the power button to adjust the sleep timer setting.

TUNE IN STATIONS

Press the [POWER] button to turn on your radio, then select your desired band by pressing [FM], [AM], SW [∨] / [∧], or [AIR] button. In case of receiving FM/AIR/SW broadcasting, fully extend the telescopic antenna for a better reception. When receiving MW and LW broadcasting, please rotate the radio or change it's location to achieve optimum reception. You can rotate the [VOLUME] knob to adjust to appropriate volume.

Now, you can turn into your favorite stations with any of the below tuning methods:

METHOD 1: MANUAL STATION TUNING

Press the [VF / VM] button to switch into frequency mode with frequency short-flash on the display, and then rotate the [TUNING] knob to select your desired station.

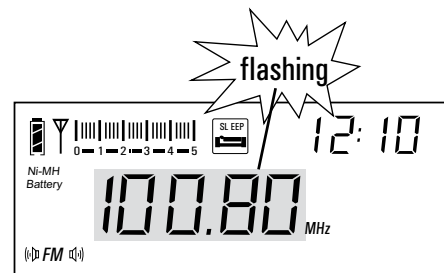

Frequency mode

METHOD 2: AUTO BROWSE STATION

1. Press the [VF / VM] button with frequency short-flash on the display to switch into frequency mode.
2. Press & hold the [VF/VM] button to scan from one station to another, staying on each station for about 5 seconds.
3. To stop the auto browse function, simply rotate the [TUNING] knob or press on the [VF / VM] button again to confirm on your desired station.

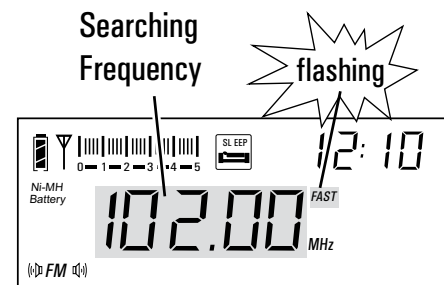

Auto browse station

Notes:

1. While operating the “Auto Browse Station” function, you can press the [MEMORY] button anytime to store the station into memory, and the radio will keep on auto browsing the next available station.
2. The “Auto Browse Station” function can't be employed under Air band and SW SSB states.

TUNE IN STATIONS

METHOD 3: DIRECT KEYPAD ENTRY

1. Press the [VF/VM] button with frequency flashing on the display to switch into frequency mode.
2. Press the numeric keys [0] - [9] to enter the station frequency directly.

Notes:

1. Ignore the decimal point for FM band when inputting the frequency numbers. For example, FM 89.3 MHz, just enter .
2. If the entered frequency rate is not within the covering area, the display would display “E r r” (error) symbol.

WORKING WITH STATION MEMORIES

There are 2000 memories for PL-660, which has great flexibility of memory storage. Please note the chart below:

1. Memory PAGE 0, noted as [P0], consists of 800 memories, 100 assigned for FM/MW/LW, 200 for SW & SSB and 100 for AIR BAND.
2. Memory PAGE 1~12, noted as P1, P2, etc., each page consists of 100 memories, in total 2000 memories.

MEMORY \ BAND	Memory for each Band (800)		Memory among all Band (1200)	
	PAGE P0	ATS	PAGE 01 ~ 12	ATS
FM	100	✓	Each Memory Page can store 100 Memories.	ATS is available for all Memory Page (except SSB & Air Band)
MW	100	✓		
LW	100	✓		
SW	200	✓		
SSB	200	✗		
AIR	100	✗		

METHOD 1: STORING STATION MANUALLY

1. Press the [FM], [MW/LW] or [SW] button for band selection, then tune into your desired station.
2. Press the [MEMORY] button with the next available “Memory Address” flashing.
3. Rotate the [TUNING] knob to specify the storing memory address.
4. Press the [MEMORY] button again to confirm. You can also wait for 3 seconds to auto store the station into memory.

METHOD 2: SEMI-AUTOMATIC STORING STATION

While operating the “Auto Browse Station” (refer to page 06) function, you can simply press the [MEMORY] button to store the station into memory to avoid unwanted stations.

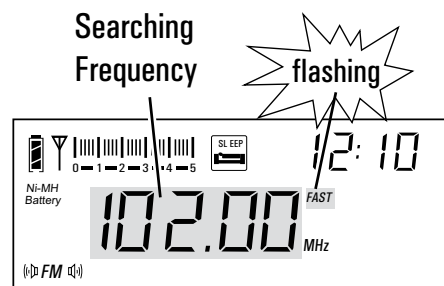

WORKING WITH STATION MEMORIES

METHOD 3: ATS (AUTO TUNING STORAGE)

FM ATS:

1. Fully extend the telescopic antenna and press the [FM] button to select FM band.
2. Press & hold the [FM] button with “PRESET” flashing and the frequency start running, then you can scan and store the available stations within the memories. When the frequency stop running, it means the ATS operation has been completed; you can rotate the [TUNING] knob searching for those scanned and stored stations.

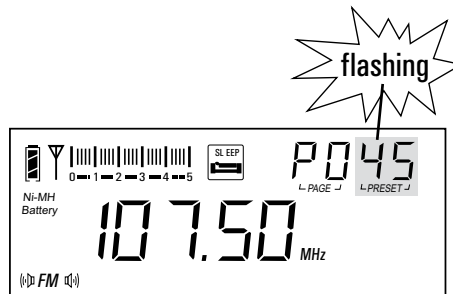

MW/LW ATS:

1. Press the [AM] button to select MW/LW band.
2. Press & hold the [AM] button for ATS MW or LW.

SW ATS:

Fully extend the telescopic antenna and press the SW [∨] or [∧] button to select SW band. There are two modes for SW ATS tuning:

Mode A: Press & hold the [∨] button to ATS the stations within all meter bands

Mode B: Press & hold the [∧] button to ATS the stations within present meter band only.

Notes:

1. During ATS process in FM, MW / LW or SW (mode A), pre-stored radio stations will be replaced automatically by the new searched stations.
2. With ATS in SW (mode B), those existing memories will not be replaced; all the newly found radio stations would be stored in the blank memories addresses.
3. If there is too many interference in you surrounding or many mirror/blank station being stored during ATS, you should contract the telescopic antenna (FM & SW) or rotate the radio (MW & LW) for better location. You can also push the [ANT. GAIN] button to the position “NORMAL” or “LOCAL” to restart ATS.

WORKING WITH STATION MEMORIES

HOW TO SELECT DIFFERENT MEMORY PAGE

1. Press the [FM], [MW/LW] or [SW] button for band selection, then tune into your desired station.
2. Press the [MEMORY] button with memory address flashing on the upper right corner
3. Press the [- PAGE +] button to choose your desired memory PAGE, then rotate the [TUNING] to select your preference memory address.
4. Press the [MEMORY] button again to confirm or wait for 3 seconds to auto store the station into memory.

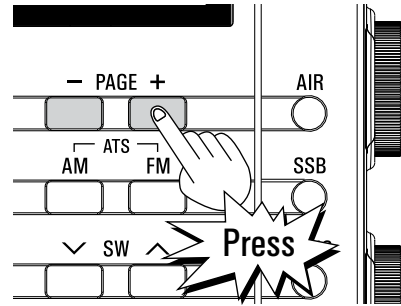

DELETE MEMORY

Press the [VF / VM] button with “Memory address” showing on upper right corner of the display to enter the [Memory] mode, and then follow below methods to delete those unwanted stations

METHOD 1: DELETE SINGLE MEMORY MANUALLY

Rotate the [TUNING] knob to select the memory that you want to delete, press & hold the [DELETE] button with “DEL” flashing; then press the [DELETE] button to remove the unwanted memory address.

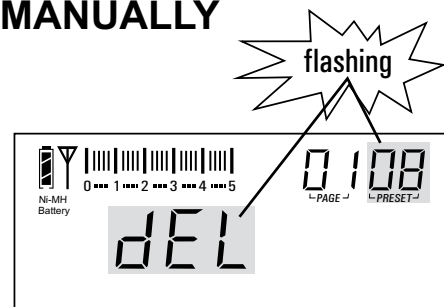

Delete Single Memory

Note:

If “DEL” is flashing more than 3 seconds without confirmation, it will exit the delete function automatically.

METHOD 2: SEMI-AUTO DELETE MEMORY

Press and hold the [VF / VM] to auto browse stations, then you can press the [DELETE] button anytime to direct delete the unwanted station; the radio will keep on auto browsing the next available station until you press any other button to stop this function.

WORKING WITH STATION MEMORIES

METHOD 3: DELETE ALL MEMORY WITHIN THE PAGE

Press & hold the [DELETE] button for 3 seconds and notice both “Memory address” & “*dEL*” flashing, then follow with “Memory Page” and “*dEL*” flashing on the upper right corner of display. Press the [DELETE] button again to delete all memory within the selected page.

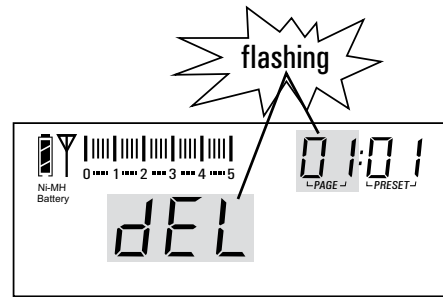

Delete ALL Memory

Note:

If the [DELETE] button has not been pressed within 3 seconds to confirm, it will exit the delete function automatically.

LISTENING TO STORED STATIONS

Select band and then press the [VF / VM] button with “Memory address” shows on the upper right corner of display to enter the [Memory] mode, press the [- PAGE +] button to select your desired page, then apply any of below three tuning methods to tune around those stored stations:

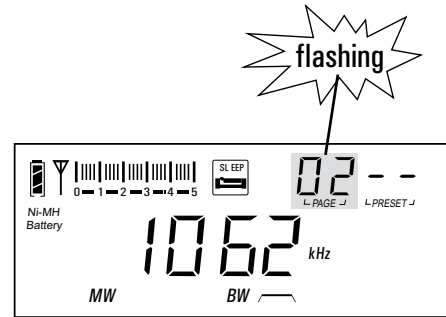

Changing memory pages

METHOD 1: MEMORY TUNING MANUALLY

Rotate the [TUNING] knob to tune around the stored station.

METHOD 2: AUTO BROWSE MEMORY

Press & hold the [VF / VM] button until “PRESET” flashing to auto scan from one memory to another, staying on each station for about 5 seconds. To stop auto search memory, simply rotate the [TUNING] knob or to press on [VF / VM] button again.

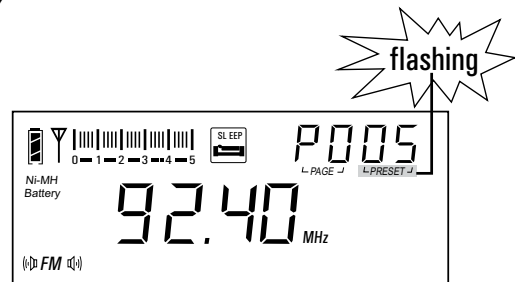

Auto browse memory

METHOD 3: DIRECT KEY IN MEMORY ADDRESS

Press the numeric keys [0] - [9] to enter the memory address directly, and then press again the ↵ button to confirm.

Note: If the display shows “ - - - - ” symbol after entering the number, it means the entered memory page/address does not exist.

SLEEP FUNCTION

1. Press & hold the [POWER] button with the symbol of “  ” flashing on the display to enter sleep timer mode.

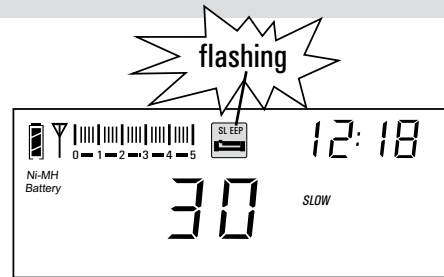

2. Rotate the [TUNING] knob immediately to select sleep timer from 1 ~ 120 minutes or select permanently “  ” (radio will be turned on after 1 second).

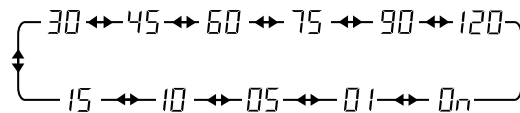

Time selection for sleep timer

Note: Default setting for the sleep timer is 30 minutes.

CLOCK SETTING

1. Press & hold the [TIME] button with hour flashing, then rotate the [TUNING] knob to adjust the hour.

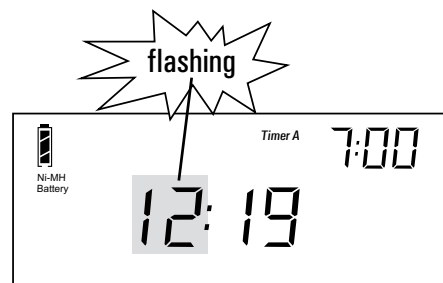

Time setting

2. Press the [TIME] button with minutes flashing, and then rotate the [TUNING] knob to adjust the minute.



3. Press again the [TIME] button to confirm the setting.

※ If the [TIME] button has not been pressed again within 3 seconds, the unit will automatically confirm the setting.

※ You can direct key in the number to set the hour/minutes instead of rotating the [Tuning] knob.

ALARM SETTING (By Radio only)

SETTING THE ALARM STATION:

1. Turn on the radio, then tune into your favorite station for alarm by radio and adjust your desired alarm volume level.
2. Press the [MEMORY] button and then immediately press the [TIMER A] or [TIMER B] button and notice “” or “” flashing on the display to confirm the preset alarm station.

SETTING THE ALARM TIME

1. Press & hold the [TIMER A] button with hour flashing in the upper right corner of display, then rotate the [TUNING] knob to adjust the hour.
2. Press the [TIMER A] button with minutes flashing, and then rotate the [TUNING] knob to adjust the minute.
3. Press the [TIMER A] button again, then rotate the [TUNING] knob to select from 1 ~ 90 minutes to set the Alarm Off Timer.
4. Press the [TIMER A] button to confirm the setting.

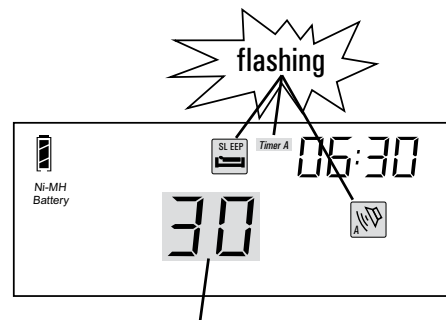



Setting timer for alarm off



※ If the [TIMER A] button has not been pressed again within 3 seconds, the unit will automatically confirm the alarm setting.

Note: The unit will turn on automatically and switch to the preset alarm station and time. It will also be turned off automatically when it reaches the preset time.

SNOOZE FUNCTION

When the preset alarm is activated, you can press the [LIGHT/SNOOZE] button with “” or “” flashing in order to turn off the alarm temporarily, but the unit will turn on again after 5 minutes later.

Notes:

1. You can press the [TIMER A] or [TIMER B] button repeatedly to turn on/off the alarm by radio.
If the symbol “” or “” shows on the display, it means the alarm by radio was activated, otherwise, it isn't activated.
2. If the preset alarm is activated, press the [POWER] button once to continuously listen to the radio; press it twice to turn off the radio.
3. If the preset alarm is activated when you are listening to the radio, it will auto switch to the preset alarm station.

INTELLIGENT LIGHT FUNCTION

This radio has an intelligent lighting function with which the backlight would be on for 3 seconds when operating any keys or knobs.

TURN ON/OFF THE BACKLIGHT:

Press the [LIGHT/SNOOZE] button to illuminate the LCD for 3 seconds; press & hold the [LIGHT/SNOOZE] button for permanently illumination. Press it again to turn off the backlight.

Notes:

1. When the unit is powered by the battery, please try to avoid setting the backlight to permanent illumination so as to reduce power consumption.
2. When the unit is turned off, the permanent illumination function will be turned off automatically as well.

SETTING TUNING STEP

The intelligent tuning step function is activated by default. You can also press & hold the [STEP] button to select fast / slow tuning with radio on. FAST/SLOW tuning is shown in the chart below for each band.

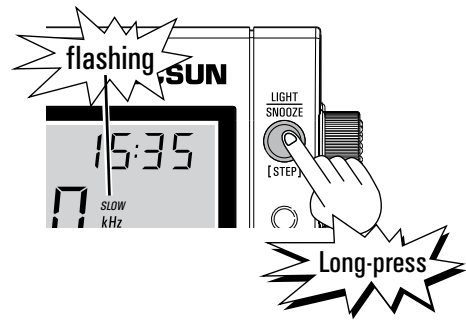

TUNING STEP BAND	FAST/SLOW TUNING STEP ("Fast/Slow" flashing on display)		SLOW TUNING STEP ("Slow" flashing on display)	
	Slowly rotate the [TUNING] knob with "Slow" indicates on display	Quickly rotate the [TUNING] knob with "Fast" indicates on display	Quickly / Slowly rotate the [TUNING] knob	
FM	0.01 MHz	0.1MHz	0.01MHz	0.01MHz
MW	1kHz	9kHz / 10kHz	1kHz	1kHz
LW	1kHz	9kHz	1kHz	1kHz
SW	1kHz	5kHz	1kHz	1kHz
AIR	1kHz	25kHz	1kHz	1kHz

FM ST. (FM STEREO)

1. While listening to FM stereo stations, press the [FM ST.] button with “ (◀▶) ” appears in the display to activate the “STEREO” listening. If the received FM broadcast signal is too weak, it is recommendable to turn off the stereo function by pressing the [FM ST.] button again with “ (◀▶) ” disappears.
2. While listening to FM stereo stations by speaker, it is recommendable to turn off the stereo function by pressing the [FM ST.] button with “ (◀▶) ” disappears to improve sound quality.
3. The stereo function will not be activated and “ (◀▶) ” will not appear if the FM station is not stereo broadcasting.

AM BW (BANDWIDTH)

Press the [AM BW] button to select your desired bandwidth for MW, LW, SW, and SSB.

Wide Band

It has better audio fidelity when receiving strong signals or local stations.

Narrow Band

It is suitable to receive weak & long distant station as narrow band is able to limit the interference from adjacent strong signal and reduce the background noise.

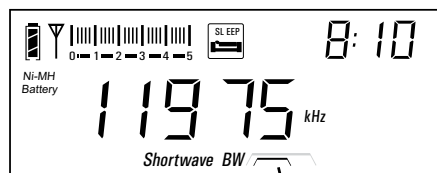

AM Bandwidth Indiction

ANT. GAIN

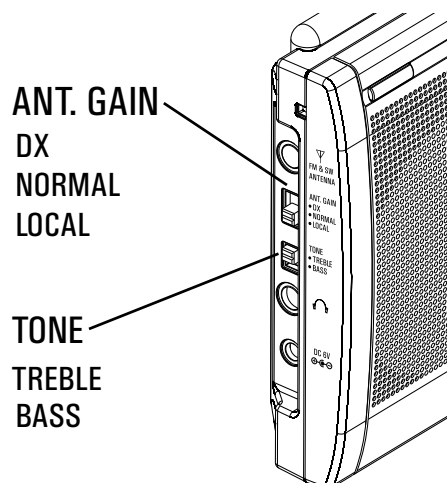

Push the [ANT. GAIN] switch to “DX” position for normal listening. But when listening to the stations with strong signal or strong electrical interference, push the [ANT.GAIN] switch to either “NORMAL” or “LOCAL” position to reduce background noise or interference.



TONE CONTROL

Push the [TONE] switch upward for “TREBLE” listening, downward or “BASS” tone.

KEY-LOCK FUNCTION

To activate the key lock function, press & hold the “” button with “” appears on display. Press & hold it again with “” disappears to deactivate the key lock function.

INTELLIGENT CHARGING FUNCTION

With radio off, install 4 x UM3 (AA) rechargeable batteries to activate the built-in charging function.

Use the external adaptor to connect the radio for charging. The symbol “” will advance from the bottom to top during power charging. It stops when batteries are fully charged.

For Alkaline batteries, please switch off the rechargeable function. (Press the [BATTERY] button until the “” is disappear at the top left corner of LCD when the radio is at off mode)

Notes:

1. Insist to use up all power of rechargeable batteries before charging again. This could extend the usage time of battery and keep them in good conditions.
2. 4pcs of batteries to be used as a group and don't separate them for other usage and mix using those batteries with different power capacity.
3. Please don't charge on any non-rechargeable battery in the radio, this will cause a hazard or damage to your radio.
4. Please do not use any other external adapter with different voltage.

SINGLE SIDE BAND (SSB)

1. In Shortwave mode, press the [SSB] button repeatedly to select Upper Side Band (USB) or Lower Side Band (LSB).
 - “USB” showing on the display indicates USB selection.
 - “LSB” showing on the display indicates LSB selection.
 - “USB” and “LSB” disappearing means switching to SW.
2. Suggest to key in the SSB frequency directly
3. Then fine tune the [SSB BFO] knob to achieve better sound fidelity.

SYNCHRONOUS DETECTOR

When receiving AM broadcasting, if there is interference from adjacent strong signals, you can activate the SYNC function to improve the reception.

1. Press the [SYNC] button to select between “ SYNC_{USB} ” or “ SYNC_{LSB} ” for optimum reception.
2. To deactivate the SYNC function, just press the [SYNC] button repeatedly with the symbols “ SYNC_{USB} ” and “ SYNC_{LSB} ” disappearing.

Notes:

1. The standard model of receiving AM station is the best normally. If there is distortion, or interfering within the AM station, please try to adjacent station signals by activating the Synchronous detection function, it can improve the reception.
2. If the "SYNC" symbol keeps flashing, it indicates that the radio signal is too weak or the frequency is deviant. It is recommended to exit the synchronization detection function as it is not able to function properly.

HOW TO IMPROVE FM / SW RECEPTION

Use the external wire antenna plug into the [FM & SW ANTENNA] jack, and then hang the other end outside the window for better FM and SW reception.

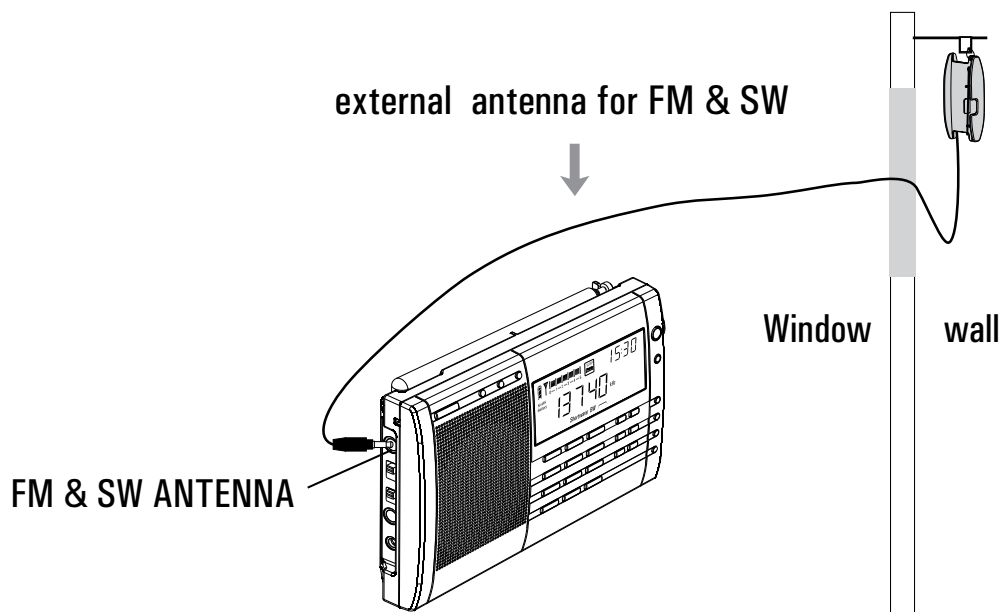

Caution: Do not install any external antenna at the area with thunder & lightning!

SYSTEM SETTING (In Power Off Mode)

SETTING FM FREQUENCY RANGE:

Press & hold the [FM SET] button until 88-108MHz, 76-108MHz or 87-108MHz appears in the display. Quickly keep on pressing the [FM SET] button to select suitable frequency range for your local FM.

TURN ON/OFF THE LW:

Press & hold the [AM] button until “LW ON” or “LW OFF” appears in the display to turn ON or OFF the LW respectively.

SETTING MW (AM) TUNING STEP:

Press & hold [9/10 kHz] button until “9kHz” or “10kHz” appears in the display to select your desired AM tuning step.

TURN ON/OFF THE INTELLIGENT AUTO LIGHTING

Factory default of intelligent auto lighting function is ON, with which the backlight would be on for 3 seconds when operating any keys or knobs.

To deactivate the Auto lighting function, press & hold the [LIGHT SET] button with the “OFF” shows in the display; press & hold the [LIGHT SET] button again with “ON” shows up to activate it.

Note: After shutting down the intelligent auto lighting function, the [LIGHT/SNOOZE] key can still be operated to turn on/off the backlight.

TURN ON/OFF THE CHARGING FUNCTION

Using Regular Batteries for power supply:

In radio off mode, press & hold the [BATTERY] key with “CHA OFF” showing up & “Ni-MH Battery” disappearing to activate the consumption display of regular batteries and turn off the built-in charging system.

Using Rechargeable Batteries for power supply:

Turn off the radio, press & hold the [BATTERY] key with “CHA ON” and “Ni-MH Battery” showing up to activate the consumption display of rechargeable batteries and turn on the built-in charging function.

Note: This radio is default to use rechargeable batteries for power supply. In case of using regular batteries, you should switch the radio system to regular batteries mode in order to show the correct power capacity.

RESET PROCEDURE

If the radio does not function properly, you can perform a reset by using a pointed object such as straightened paper clip, into the [RESET] hole in the bottom of the unit, and gently press and release.

Note:

Station memory will not be removed after you push the reset button.

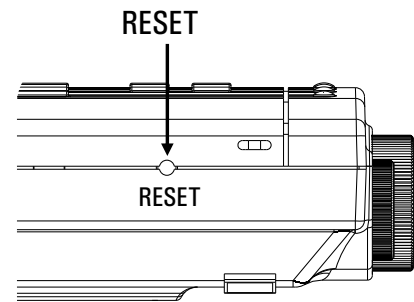

Located at the bottom of radio

IMPORTANT MATTERS FOR USING BATTERIES

1. The Clock memory will be gone if the unit has no power supplied by either batteries or adaptor for a long time, but the pre-stored frequencies will still be kept.
2. When the battery power is low, the "  " symbol in the display will flash to alert you for changing new batteries. And it will turn off automatically when the power is gone.
3. Mix using the used & new batteries would cause damage of radio and incorrect display of power capacity.
4. In order to avoid leakage, always remove the batteries when the unit will not be used for a long period of time.

TROUBLE SHOOTING

QUESTIONS	ANSWERS	SOLUTIONS
Can not turn on the radio.	<ul style="list-style-type: none"> - Batteries have no power - Installing batteries incorrectly - Key knob function is being activated. 	<ul style="list-style-type: none"> - Replace all batteries with new one. - Observing the polarities of battery, then re-install all batteries again. - Press the [M-O] button to deactivated it.
Radio turn off while listening.	<ul style="list-style-type: none"> - Batteries have no power - Sleep timer is being activated. 	<ul style="list-style-type: none"> - Replace all batteries. -Turn on the radio again.
During ATS, some station cannot be stored. Some stored station with noise.	<ul style="list-style-type: none"> - Frequency of stations are too weak. - There is interference near by your area. 	<ul style="list-style-type: none"> - Search the station manually. - Low down the antenna or move to other location and try again.
Only limited FM stations can be received.	-FM frequency might be set as 76~90MHz accidentally.	- Turn off the radio, press & hold the [FM SET] button to select the accurate FM frequency range.
Poor AM reception in USA.	- USA is using 10kHz AM tuning step not 9kHz.	- Turn off the radio press the [9/10kHz] button to select accurate tuning step.
The sound of SW SSB broadcasting is too low.	The default bandwidth is Narrow band.	Press the [AM BW] button to select the Wide band.

TROUBLE SHOOTING

QUESTIONS	ANSWERS	SOLUTIONS
<p>When the alarm is on, there is only noise with the broadcast.</p>	<p>-Did not set the proper radio station for the alarm.</p> <p>-Or there is no broadcasting at that radio station.</p> <p>-Or you are in another city where does not have a radio station for your preset frequency.</p>	<p>-Preset your alarm station properly</p> <p>-Make sure it has radio broadcast in your location.</p>
<p>The charging time becomes shorter and shorter.</p>	<p>The chargeable batteries getting old.</p>	<p>Replace the old rechargeable batteries with new ones.</p>
<p>Radio malfunction.</p>	<p>This may caused by interference, and the computer microchip does not function properly.</p>	<p>Remove all batteries, then reload again. If it is still not working, please press on the reset button with a pointed object.</p>

SPECIFICATIONS

1. Frequency Range:

FM: 76~108 / 87~108 MHz Step: 0.01MHz / 0.1 MHz

MW: 522~1620 / 520~1710 kHz

Tuning Step: 9K for North America or other countries/10K for South America

LW: 100~519 kHz Step: 1 kHz/ 9 kHz

SW: 1711~29999 kHz Step: 1 kHz/ 5 kHz

AIR:118~137MHz Step: 1kHz / 25 kHz

2. Sensitivity

FM (S/N=30dB) Less than 3uV

MW (S/N=26dB) Less than 1mV/m

LW (S/N=26dB) Less than 5mV/m

SW (S/N=26dB) Less than 20uV

SSB(S/N=10dB) Less than 1uV

AIR (S/N=10dB) Less than 5uv

3. Selectivity

FM > 30 dB (± 200 kHz)

MW/LW > 40 dB (± 9 kHz)

SW > 40 dB (± 5 kHz)

4. S/N Ratio

FM Less than 60dB

MW/LW Less than 45dB

SW Less than 50dB

5. AM Frequency

SSB, AM 1st IF: 55.845MHz

2nd IF: 455 kHz

FM: 10.7MHz

6. FM Stereo crosstalk Less than 20 dB

7. Output Power

Speaker \geq 450 mW

Earphone \geq 10 mW

FEATURES

- FM-Stereo / MW / LW / SW SSB / AIR band (118~137 MHz) World Receiver with high sensitivity and selectivity
- Easy operation and with high quality acoustic sound
- Worldwide FM band coverage from 76MHz to 108MHz
- Shortwave single-sideband (SSB) with upper sideband (USB) and lower sideband (LSB)
- Synchronous detection and dual conversion technology are applied on AM band. (Major improvement on receiver's sensitivity, selectivity, anti-inter-modulation, and channel interference)
- External antenna jack for FM/SW
- 3 levels sensitivity selector (High / Medium / Low)
- Multi Tuning Methods:
 - Auto Tuning Storage (ATS)
 - Auto Scan Tuning with 5 seconds Pre-listening function
 - Manual Tuning
 - Direct keypad Entry
- Store up to 2000 stations (manually, semi-automatic and fully automatic)
 - 100 memories for FM / AM / Longwave / Air Band
 - 200 memories for Shortwave
 - 200 memories for SSB
 - 1200 memories for various bands (12 pages x 100 memories)
- Acoustic speaker with treble / bass tone control switch (FM Stereo via earphone)
- Easy to use with multi-functional control knob, which is for setting timer, frequency tuning, select the page and memory
- Dual timer to turn on the preset radio station.
- Adjustable timer (1 ~ 120 minutes) for radio power off automatically (adjustable timer can be switch off for long period of listening)
- 9K/10K Tuning step for MW
- DX/Normal/Local Antenna Gain
- Back Light and Snooze Function
- Signal Strength & Battery Consumption Display
- Direct Reset Function
- 4 x AA (UM3) size batteries, DC-6V
- Dimension: 187 x 114 x 33 mm

SPECIFICATIONS

8. Station Memory 2000M in total

- 800 memories for each band:
FM: 100M
MW: 100M
LW: 100M
SW: 200M
SSB: 200M
AIR: 100M
- 1200 memories for 12 memory pages (each page 100 memories)

9. Alarm Mode: alarm by radio only (2 presettings)

10. Quiescent Current

- FM < 50mA
- MW/LW < 70mA
- SW < 70mA
- SSB < 70mA
- AIR < 70mA
- Standby < 80uA

11. Speaker: Φ 77 mm / 16 Ohm / 1W Cone speaker

12. Earphone Jack: Φ 3.5mm, 32 Ohm, Stereo type

13. Power supply:

- Battery: UM3 or AA X 4
- External adaptor: DC 6V, \geq 300mA

14. Unit Dimensions: approx. 187(W) X 114(H) X 33(D) mm

15. Weight: 470g (Batteries not included)